



HT750•LS
MTX150
MTX450
MTX1500
MTX4500

Portable Radios

quality

versatility



As Dedicated As You Are™

Professional Radio

Supplement to
Basic Service Manual (Canada Only)

Professional Portable Radio Basic Service Manual 68P80906Z54

COMPUTER SOFTWARE COPYRIGHTS

The Motorola products described in this manual may include copyrighted Motorola computer programs stored in semiconductor memories or other media. Laws in the United States and other countries preserve for Motorola certain exclusive rights for copyrighted computer programs including, but not limited to, the exclusive right to copy or reproduce in any form the copyrighted computer program. Accordingly, any copyrighted Motorola computer programs contained in the Motorola products described in this manual may not be copied, reproduced, modified, reverse-engineered, or distributed in any manner without the express written permission of Motorola. Furthermore, the purchase of Motorola products shall not be deemed to grant either directly or by implication, estoppel, or otherwise, any license under the copyrights, patents or patent applications of Motorola, except for the normal non-exclusive license to use that arises by operation of law in the sale of a product.

This document supplements the information in the
Basic Service Manual Part Number 68P80906Z54-B.

Supplement Basic Service Manual 68P80906Z54-B contains
VHF information for the following portable radio models:

- HT750•LS
- MTX150
- MTX450
- MTX1500
- MTX4500

SAFETY AND GENERAL INFORMATION

IMPORTANT INFORMATION ON SAFE AND EFFICIENT OPERATION

READ THIS INFORMATION BEFORE USING YOUR MOTOROLA TWO-WAY RADIO

The information provided in this document supersedes the general safety information contained in user guides published prior to October 2000. For information regarding radio use in a hazardous atmosphere refer to the Factory Mutual (FM) manual supplement included with radio models that offer this capability and/or the intrinsic safety radio information section of this user manual.

RADIO FREQUENCY (RF) OPERATIONAL CHARACTERISTICS

To transmit (talk) you must push the Push-To-Talk button; to receive (listen) you must release the Push-To-Talk button. When the radio is transmitting, it generates radio frequency (RF) energy; when it is receiving, or when it is off, it does not generate RF energy.

PORTABLE RADIO OPERATION AND EME EXPOSURE

Your Motorola radio is designed to comply with the following national and international standards and guidelines regarding exposure of human beings to radio frequency electromagnetic energy (EME):

- United States Federal Communications Commission, Code of Federal Regulations; 47 CFR part 2 sub-part J
- American National Standards Institute (ANSI) / Institute of Electrical and Electronic Engineers (IEEE) C95. 1-1992
- Institute of Electrical and Electronic Engineers (IEEE) C95.1-1999 Edition
- National Council on Radiation Protection and Measurements (NCRP) of the United States, Report 86, 1986
- International Commission on Non-Ionizing Radiation Protection (ICNIRP) 1998
- Ministry of Health (Canada) Safety Code 6. Limits of Human Exposure to Radio Frequency Electromagnetic Fields in the Frequency Range from 3 kHz to 300 GHz, 1999
- Australian Communications Authority Radiocommunications (Electromagnetic Radiation - Human Exposure) Standard 1999 (applicable to wireless phones only)

To assure optimal radio performance and make sure human exposure to radio frequency electromagnetic energy is within the guidelines set forth in the above standards, always adhere to the following procedures:

Two-way Radio Operation

When using your radio, **hold the radio in a vertical position with the microphone one to two inches (2.5 to 5 centimeters) away from the lips.**

Body-worn Operation

To maintain compliance with FCC RF exposure guidelines, if you wear a radio on your body when transmitting, always place the radio in a **Motorola approved clip, holder, holster, case, or body harness for this product.** Use of non-Motorola-approved accessories may exceed FCC RF exposure guidelines. **If you do not use a Motorola approved body-worn accessory and are not using the radio in the intended use positions along side of the head in the phone mode or in front of the face in the two-way radio mode, then ensure the antenna and radio is kept the following minimum distances from the body when transmitting:**

- Phone or Two-way radio mode: one inch (2.5 centimeters)
- Data operation using any data feature with or without an accessory cable: one inch (2.5 centimeters)



Antenna Care

Use only the supplied or an approved replacement antenna. Unauthorized antennas, modifications, or attachments could damage the radio and may violate FCC regulations.

DO NOT hold the antenna when the radio is “IN USE”. Holding the antenna affects call quality and may cause the radio to operate at a higher power level than needed.

Approved Accessories

For a list of approved Motorola accessories look in the appendix or accessory section of your radio's User Guide.

ELECTROMAGNETIC INTERFERENCE/COMPATIBILITY

Note: Nearly every electronic device is susceptible to electromagnetic interference (EMI) if inadequately shielded, designed or otherwise configured for electromagnetic compatibility.

Facilities

To avoid electromagnetic interference and/or compatibility conflicts, turn off your radio in any facility where posted notices instruct you to do so. Hospitals or health care facilities may be using equipment that is sensitive to external RF energy.

Aircraft

When instructed to do so, turn off your radio when on board an aircraft. Any use of a radio must be in accordance with applicable regulations per airline crew instructions.

Medical Devices

- **Pacemakers**

The Health Industry Manufacturers Association recommends that a minimum separation of 6 inches (15 centimeters) be maintained between a handheld wireless radio and a pacemaker. These recommendations are consistent with those of the U.S. Food and Drug Administration.

Persons with pacemakers should:

- ALWAYS keep the radio more than 6 inches (15 centimeters) from their pacemaker when the radio is turned ON.
- Not carry the radio in the breast pocket.
- Use the ear opposite the pacemaker to minimize the potential for interference.
- Turn the radio OFF immediately if you have any reason to suspect that interference is taking place.

- **Hearing Aids**

Some digital wireless radios may interfere with some hearing aids. In the event of such interference, you may want to consult your hearing aid manufacturer to discuss alternatives.

- **Other Medical Devices**

If you use any other personal medical device, consult the manufacturer of your device to determine if it is adequately shielded from RF energy. Your physician may be able to assist you in obtaining this information.

SAFETY AND GENERAL

Use While Driving

Check the laws and regulations on the use of radios in the area where you drive. Always obey them.

When using your radio while driving, please:

- Give full attention to driving and to the road.
- Use hands-free operation, if available.
- Pull off the road and park before making or answering a call if driving conditions so require.

OPERATIONAL WARNINGS



WARNING

FOR VEHICLES WITH AN AIR BAG

Do not place a portable radio in the area over an air bag or in the air bag deployment area. Air bags inflate with great force. If a portable radio is placed in the air bag deployment area and the air bag inflates, the radio may be propelled with great force and cause serious injury to occupants of the vehicle.

POTENTIALLY EXPLOSIVE ATMOSPHERES

Turn off your radio prior to entering any area with a potentially explosive atmosphere, unless it is a radio type especially qualified for use in such areas as "Intrinsically Safe" (for example, Factory Mutual, CSA, UL, or CENELEC). Do not remove, install, or charge batteries in such areas. Sparks in a potentially explosive atmosphere can cause an explosion or fire resulting in bodily injury or even death.

Note: The areas with potentially explosive atmospheres referred to above include fueling areas such as below decks on boats, fuel or chemical transfer or storage facilities, areas where the air contains chemicals or particles, such as grain, dust or metal powders, and any other area where you would normally be advised to turn off your vehicle engine. Areas with potentially explosive atmospheres are often but not always posted.

BLASTING CAPS AND AREAS

To avoid possible interference with blasting operations, turn off your radio when you are near electrical blasting caps, in a blasting area, or in areas posted: "Turn off two-way radio." Obey all signs and instructions.

OPERATIONAL CAUTIONS



Caution

ANTENNAS

Do not use any portable radio that has a damaged antenna. If a damaged antenna comes into contact with your skin, a minor burn can result.

BATTERIES

All batteries can cause property damage and/or bodily injury such as burns if a conductive material such as jewelry, keys, or beaded chains touch exposed terminals. The conductive material may complete an electrical circuit (short circuit) and become quite hot. Exercise care in handling any charged battery, particularly when placing it inside a pocket, purse, or other container with metal objects.

This page intentionally left blank

Table of Contents

SAFETY AND GENERAL INFORMATION	i
• RADIO FREQUENCY (RF) OPERATIONAL CHARACTERISTICS	i
• PORTABLE RADIO OPERATION AND EME EXPOSURE	i
• ELECTROMAGNETIC INTERFERENCE/COMPATIBILITY	ii
• SAFETY AND GENERAL	iii
• OPERATIONAL WARNINGS	iii
• OPERATIONAL CAUTIONS	iii

Chapter 1 *Introduction*

1.1	Scope of Manual	1-1
1.2	Warranty and Service Support	1-1
1.2.1	Warranty Period and Return Instructions	1-1
1.2.2	After Warranty Period	1-1
1.2.3	Piece Parts Availability	1-2
1.2.4	Technical Support	1-3
1.3	Radio Model Information	1-4

Chapter 2 *Intrinsically Safe Radio Information*

2.1	FMRC Approved Equipment	2-1
2.2	Repair of FMRC Approved Products	2-2
2.2.1	Repair	2-2
2.2.2	Relabeling	2-2
2.2.3	Do Not Substitute Options or Accessories	2-2

Chapter 3 *Maintenance*

3.1	HT750•LS Radio Exploded Mechanical View and Parts List	3-1
3.2	MTX450 Radio Exploded Mechanical View and Parts List	3-2
3.3	MTX4500 Radio Exploded Mechanical View and Parts List	3-3
3.4	MTX150 Radio Exploded Mechanical View and Parts List	3-4
3.5	MTX1500 Radio Exploded Mechanical View and Parts List	3-5

Chapter 4 *Transceiver Performance Testing*

4.1	RF Test Mode	4-1
-----	--------------------	-----

Chapter 5 *Radio Tuning, Programming, and Cloning*

5.1	Cloning (Conventional and LTR)	5-1
5.1.1	Error Codes (Display Radios Only)	5-2
5.2	Cloning (Privacy Plus)	5-2

Chapter 6 *Power Up Self-Test*

6.1	Error Codes - Conventional and LTR Radios	6-1
6.2	Error Codes - Privacy Plus	6-2

Chapter 7 *Accessories*

7.1	HT750•LS/MTX450/MTX4500/MTX150/MTX1500 Accessories	7-1
7.1.1	Antennas	7-1
7.1.2	Carrying Accessories	7-1
7.1.3	Carry Cases	7-1
7.1.4	Chargers	7-2
7.1.5	Batteries	7-2
7.1.6	Adaptors	7-2
7.1.7	Miscellaneous	7-2
7.1.8	Service Aids	7-2
7.1.9	Audio Accessories	7-3
7.1.10	Option Boards (HT750•LS only)	7-3
7.1.11	Remote Speaker Microphones	7-3
7.1.12	Manuals	7-4
7.1.13	Retrofit Front Cover Kits	7-4

Chapter 8 *Model Chart and Test Specifications*

8.1	UHF 403-470 MHz (HT Series)	8-1
8.2	UHF 403-470 MHz (MTX Series)	8-1
8.3	VHF 136-174 MHz (MTX Series)	8-2
8.4	Specifications - HT750•LS/MTX450/MTX4500/MTX150/MTX1500 Radios	8-3

List of Figures

Figure 3-1	HT750•LS Radio Exploded Mechanical View and Parts List.....	3-3
Figure 3-2	MTX450 Radio Exploded Mechanical View and Parts List.....	3-4
Figure 3-3	MTX4500 Radio Exploded Mechanical View and Parts List.....	3-5
Figure 3-4	MTX150 Radio Exploded Mechanical View and Parts List.....	3-6
Figure 3-5	MTX1500 Radio Exploded Mechanical View and Parts List.....	3-7
Figure 4-1	Radio Side Button Locations	4-3
Figure 4-2	Two-Line Display	4-3
Figure 5-1	Radio Side Button Locations	5-1

List of Tables

Table 1-1	Radio Model Number (Example: AAH25RDC9GB3AN)	1-4
Table 4-1	Receiver Performance Checks	4-4
Table 4-2	Transmitter Performance Checks	4-5
Table 6-1	Power-up Display Codes - (Conventional Radios)	6-1
Table 6-2	Power-up Display Codes	6-2

Chapter 1

Introduction

1.1 Scope of Manual

This manual is intended for use by service technicians familiar with similar types of equipment. It contains service information required for the equipment described and is current as of the printing date. Changes which occur after the printing date may be incorporated by a complete Manual revision or alternatively as additions.

NOTE Before operating or testing these units, please read the Safety Information Section in the front of this manual.

1.2 Warranty and Service Support

Motorola offers support which includes: full exchange and/or repair of the product during the warranty period; and service/repair or spare parts support out of warranty. Any “return for exchange” or “return for repair” to an authorized Motorola Dealer must be accompanied by a Warranty Claim Form. Warranty Claim Forms are obtained by contacting an Authorized Motorola Dealer. (See section 1.2.4 on page 1-3.)

1.2.1 Warranty Period and Return Instructions

The terms and conditions of warranty are defined fully in the Motorola Dealer or Distributor or Reseller contract. These conditions may change from time to time, and the following subsections are for guidance purposes only.

In instances where the product is covered under a “return for replacement” or “return for repair” warranty, a check of the product should be performed prior to shipping the unit back to Motorola. This is to ensure that the product has been correctly programmed or has not been subjected to damage outside the terms of the warranty.

Prior to shipping any radio back to the appropriate Motorola warranty depot, please contact Customer Resources (Please see page 2 and page 3 in this chapter.). All returns must be accompanied by a Warranty Claim Form, available from your Customer Resources representative. **Products should be shipped back in the original packaging**, or correctly packaged to ensure that no damage occurs in transit.

1.2.2 After Warranty Period

After the Warranty period, Motorola continues to support its products in two ways:

1. Motorola's Radio Parts and Service Group offers repair service to users and dealers at competitive prices.
2. AAD supplies individual parts and modules that can be purchased by Dealers who are capable of performing fault analysis and repair.

1.2.3 Piece Parts Availability

Some replacement parts, spare parts, and/or product information can be ordered directly. If a complete Motorola part number is assigned to the part, and it is not identified as Depot ONLY, it is available from the Accessories and Aftermarket Division (AAD). If no part number is assigned, the part is not normally available from Motorola. If the part number is appended with an asterisk, the part is serviceable by a Motorola Depot only. If a parts list is not included, this generally means that no user-serviceable parts are available for that kit or assembly.

Parts Order Entry

7:00 A.M. to 7:00 P.M. (Central Standard Time)

Monday through Friday (Chicago, U.S.A.)

To Order Parts:

1-800-422-4210, or 847-538-8023 (Voice)

1-847-538-8198 (Fax)

After hours or weekends:

1-800-925-4357

Motorola Parts

Accessories and Aftermarket Division

(United States and Canada)

Attention: Order Processing

1313 E. Algonquin Road

Schaumburg, IL 60196

Parts Identification

1-847-538-0021 or 1-800-422-4210 (Voice)

1-847-538-8194 (Fax)

1.2.4 Technical Support

Technical support is available to assist the dealer/distributor in resolving any malfunction which may be encountered. Initial contact should be by telephone to Customer Resources wherever possible. When contacting Motorola Technical Support, be prepared to provide the product **model number** and the unit's **serial number**.

For service you can contact the following Depot. Please call and confirm your return prior to sending the unit to the depot for service.

Motorola Toronto Service Centre

3900 Victoria Park Avenue

North York, Ontario, Canada M2H 3H7

1-800-543-3222

1-416-756-5841

1-888-331-9872 (Fax)

1.3 Radio Model Information

The model number and serial number are located on a label attached to the back of your radio. You can determine the RF output power, frequency band, protocols, and physical packages. The example below shows one portable radio model number and its specific characteristics.

Table 1-1: Radio Model Number (Example: AAH25RDC9GB3)

	Type of Unit	Model Series	Freq. Band	Power Level	Physical Packages	Channel Spacing	Protocol	Feature Level	Model Revision	Model Package
AA or LA = Motorola Internal Use ↑	H ↑ H = Portable	25	R UHF1 (403-470 MHz)	D 4-5W	C HT750•LS MTX450 MTX150 MTX850 MTX950	9 Program- mable	DU LTR	3 HT750•LS MTX450 MTX150 MTX850 MTX950	A	N
			K (136 -174 MHz)		H MTX4500 MTX1500 MTX8250 MTX9250		GB Privacy Plus	6 MTX4500 MTX1500 MTX8250 MTX9250		
							GE Privacy Plus w/Roaming			

Chapter 2

Intrinsically Safe Radio Information

2.1 FMRC Approved Equipment

Anyone intending to use a radio in a location where hazardous concentrations of flammable material exist (hazardous atmosphere) is advised to become familiar with the subject of intrinsic safety and with the National Electric Code NFPA 70 (National Fire Protection Association) Article 500 (hazardous [classified] locations).

An Approval Guide, issued by Factory Mutual Research Corporation (FMRC), lists manufacturers and the products approved by FMRC for use in such locations. FMRC has also issued a voluntary approval standard for repair service ("Class Number 3605").

FMRC Approval labels are attached to the radio to identify the unit as being FM Approved for specified hazardous atmospheres. This label specifies the hazardous Class/Division/Group along with the part number of the battery that must be used. Depending on the design of the portable unit, this FM label can be found on the back of the radio housing or the bottom of the radio housing. Their Approval mark is shown below.



WARNING: Do not operate radio communications equipment in a hazardous atmosphere unless it is a type especially qualified (e.g. FMRC Approved) for such use. An explosion or fire may result.

WARNING: Do not operate the FMRC Approved Product in a hazardous atmosphere if it has been physically damaged (e.g. cracked housing). An explosion or fire may result.

WARNING: Do not replace or charge batteries in a hazardous atmosphere. Contact sparking may occur while installing or removing batteries and cause an explosion or fire.

WARNING: Do not replace or change accessories in a hazardous atmosphere. Contact sparking may occur while installing or removing accessories and cause an explosion or fire.

WARNING: Do not operate the FMRC Approved Product unit in a hazardous location with the accessory contacts exposed. Keep the connector cover in place when accessories are not used.

WARNING: Turn radio off before removing or installing a battery or accessory.

WARNING: Do not disassemble the FMRC Approved Product unit in any way that exposes the internal electrical circuits of the unit.

Radios must ship from the Motorola manufacturing facility with the hazardous atmosphere capability and FM Approval labeling. **Radios will not be "upgraded" to this capability and labeled in the field.**

A modification changes the unit's hardware from its original design configuration. **Modifications can only be done by the original product manufacturer at one of its FMRC audited manufacturing facilities.**



WARNING: Failure to use an FMRC Approved Product unit with an FMRC Approved battery or FMRC Approved accessories specifically approved for that product may result in the dangerously unsafe condition of an unapproved radio combination being used in a hazardous location.

Unauthorized or incorrect modification of an FMRC Approved Product unit will negate the Approval rating of the product.

2.2 Repair of FMRC Approved Products

REPAIRS FOR MOTOROLA FMRC APPROVED PRODUCTS ARE THE RESPONSIBILITY OF THE USER.

You should not repair or relabel any Motorola manufactured communication equipment bearing the FMRC Approval label ("FMRC Approved Product") unless you are familiar with the current FMRC Approval standard for repairs and service ("Class Number 3605").

You may want to consider using a repair facility that operates under 3605 repair service approval.



WARNING: Incorrect repair or relabeling of any FMRC Approved Product unit could adversely affect the Approval rating of the unit.

WARNING: Use of a radio that is not intrinsically safe in a hazardous atmosphere could result in serious injury or death.

FMRC's Approval Standard Class Number 3605 is subject to change at any time without notice to you, so you may want to obtain a current copy of 3605 from FMRC. Per the December, 1994 publication of 3605, some key definitions and service requirements are as follows:

2.2.1 Repair

A repair constitutes something done internally to the unit that would bring it back to its original condition Approved by FMRC. A repair should be done in an FMRC Approved facility.

Items not considered as repairs are those in which an action is performed on a unit which does not require the outer casing of the unit to be opened in a manner which exposes the internal electrical circuits of the unit. You do not have to be an FMRC Approved Repair Facility to perform these actions.

2.2.2 Relabeling

The repair facility shall have a method by which the replacement of FMRC Approval labels are controlled to ensure that any relabeling is limited to units that were originally shipped from the Manufacturer with an FM Approval label in place. FMRC Approval labels shall not be stocked by the repair facility. An FMRC Approval label shall be ordered from the original manufacturer as needed to repair a specific unit. Replacement labels may be obtained and applied by the repair facility providing satisfactory evidence that the unit being relabeled was originally an FMRC Approved unit. Verification may include, but is not limited to: a unit with a damaged Approval label, a unit with a defective housing displaying an Approval label, or a customer invoice indicating the serial number of the unit and purchase of an FMRC Approved model.

2.2.3 Do Not Substitute Options or Accessories

The Motorola communications equipment certified by Factory Mutual is tested as a system and consists of the FM Approved portable, FM Approved battery, and FM Approved accessories or options, or both. This Approved portable and battery combination must be strictly observed. There must be no substitution of items, even if the substitute has been previously Approved with a different Motorola communications equipment unit. Approved configurations are listed in the FM Approval guide published by FMRC, or in the product FM Supplement. This FM Supplement is shipped with FM

Approved radio and battery combination from the manufacturer. The Approval guide, or the Approval standard Class Number 3605 document for repairs and service, can be ordered directly through Factory Mutual Research Corporation located in Norwood, Massachusetts.

3.1 HT750•LS Radio Exploded Mechanical View and Parts List

Item	Motorola Part Number	Description
1	See Accessories Chapter	Antenna
2	3680529Z01	Knob, Volume
3	3680530Z01	Knob, Channel Selector
4	1380525Z01	Escutcheon, Top
5	3380644Z01	Escutcheon, Label
6	3280533Z01	Seal, Control Top
7	6180527Z01	Litepipe, Tx
8	HHLN4059 HHLN4071	Nameplate, HT750•LS Nameplate, HT750•LS DTMF
9	1586059A01	Dust Cover, Universal Connector
10	1386058A01	Escutcheon, Universal Flex
11	1580666Z03 1580666Z04	Front Cover, Basic Front Cover with Keypad (DTMF)
12	Not Field Replaceable	Escutcheon, FM
13	7580532Z01	Keypad, Side Control
14	1380528Z01	Bezel, Side Control
15	7580620Z03 7580620Z04	Keypad, Blank Keypad, Full
16	0104007J99	Keypad Board Assembly
17	4280498Z01	Retainer, Keypad PCB
18	3586057A01	Felt Speaker
19	1480577C01	Boot, Microphone
20	5085962A02	Speaker
21	5013920A04	Microphone
22	8480549Z01	Flex Speaker-Microphone
23	2113740A41	Capacitor, 33pF
24	4280504Z01	Retainer, Speaker
25	0304726J04	Screw
26	See section 8.1	Ctrl/RF Board Assembly
27	8480475Z02	Flex, Keypad/Controller
28	1480652Z01	Insulator, Antenna
29	7580556Z01	Pad, Thermal
30	3280534Z01	Seal, Contact
31	3280536Z01	Gasket, O-Ring
32	3980698Z01	Contact, Ground, Compliant, UHF
33	2780518Z01	Chassis
34	See Accessories Chapter	Battery
35	HLN9714	Beltclip

3.2 MTX450 Radio Exploded Mechanical View and Parts List

Item	Motorola Part Number	Description
1	See Accessories Chapter	Antenna
2	3680529Z01	Knob, Volume
3	3680530Z01	Knob, Channel Selector
4	1380525Z01	Escutcheon, Top
5	3380644Z01	Escutcheon, Label
6	3280533Z01	Seal, Control Top
7	6180527Z01	Litepipe, Tx
8	HHLN4212	Nameplate, MTX450
9	1586059A01	Dust Cover, Universal Connector
10	1386058A01	Escutcheon, Universal Flex
11	1580666Z03 1580666Z04	Front Cover, Basic Front Cover with Keypad (DTMF)

Item	Motorola Part Number	Description
12	Not Field Replaceable	Escutcheon, FM
13	7580532Z01	Keypad, Side Control
14	1380528Z01	Bezel, Side Control
15	7580620Z03 7580620Z04	Keypad, Blank Keypad, Full
16	0104007J99	Keypad Board Assembly
17	4280498Z01	Retainer, Keypad PCB
18	3586057A01	Felt Speaker
19	1480577C01	Boot, Microphone
20	5085962A02	Speaker
21	5013920A04	Microphone
22	8480549Z01	Flex Speaker-Microphone
23	2113740A41	Capacitor, 33pF

Item	Motorola Part Number	Description
24	4280504Z01	Retainer, Speaker
25	0304726J04	Screw
26	See section 8.1	Ctrl/RF Board Assembly
27	8480475Z02	Flex, Keypad/Controller
28	1480652Z01	Insulator, Antenna
29	7580556Z01	Pad, Thermal
30	3280534Z01	Seal, Contact
31	3280536Z01	Gasket, O-Ring
32	3980698Z01	Contact, Ground, Compliant, UHF
33	2780518Z01	Chassis
34	See Accessories Chapter	Battery
35	HLN9714	Beltclip

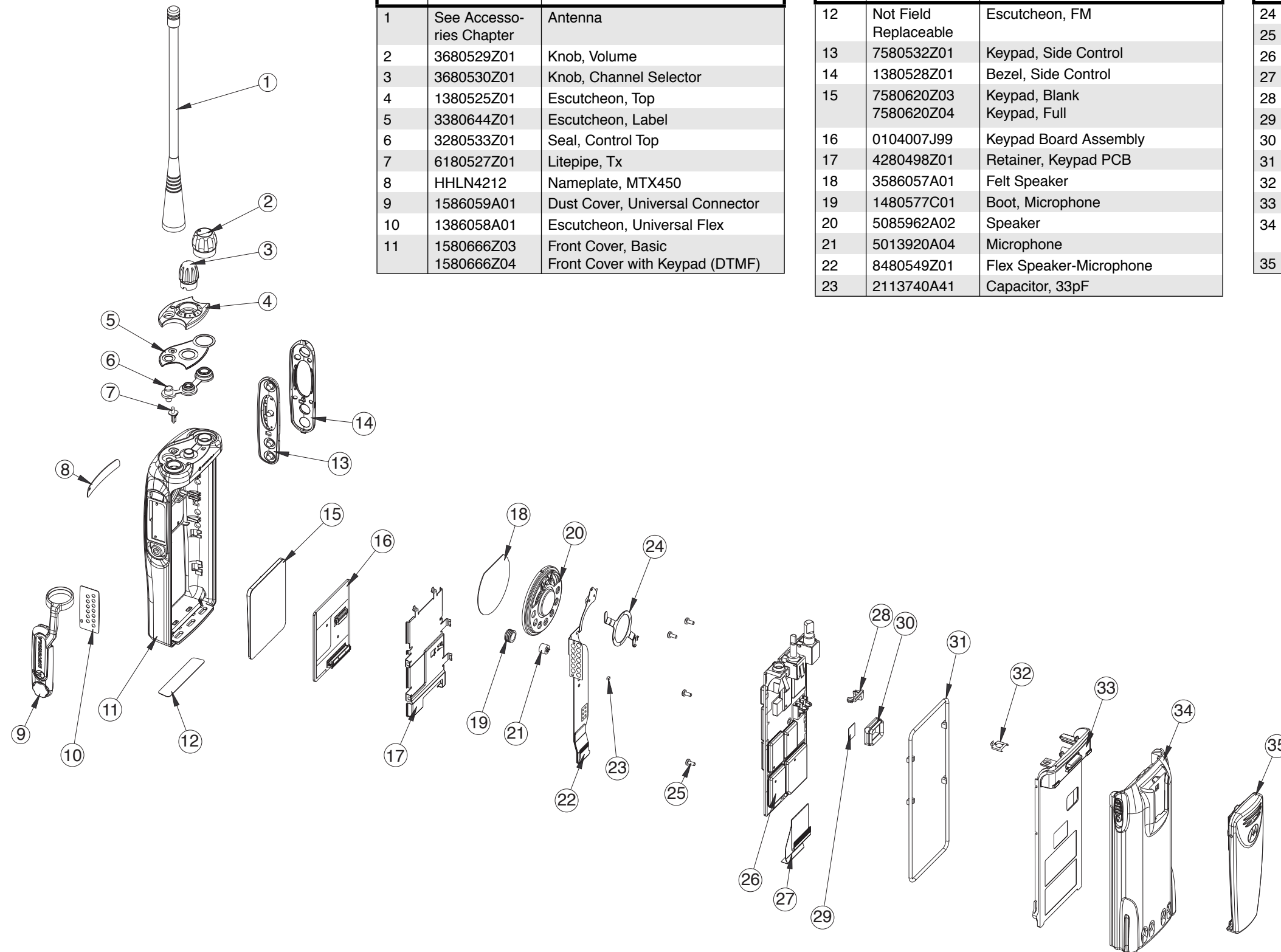

3.3 MTX4500 Radio Exploded Mechanical View and Parts List

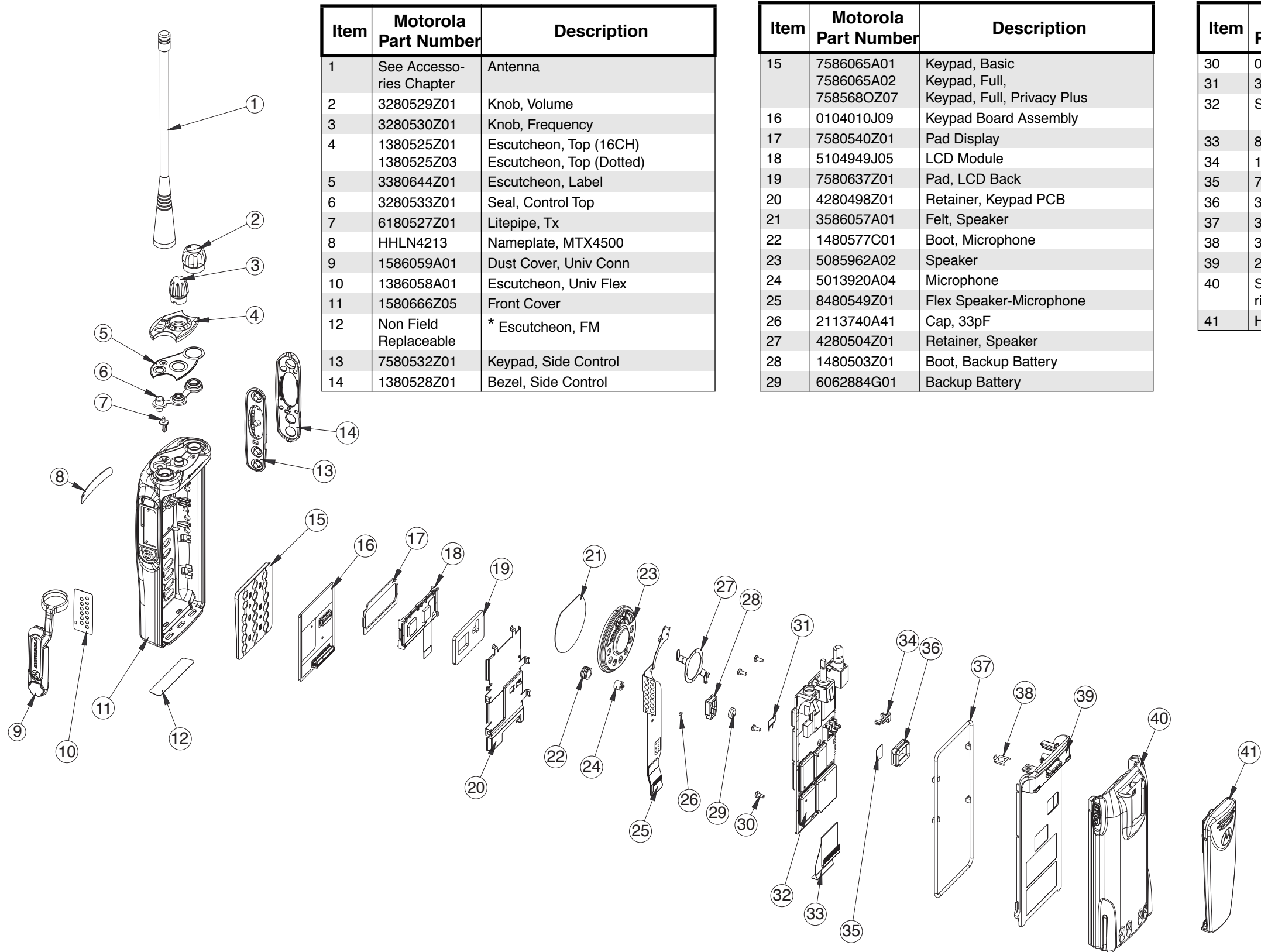

Item	Motorola Part Number	Description
1	See Accessories Chapter	Antenna
2	3280529Z01	Knob, Volume
3	3280530Z01	Knob, Frequency
4	1380525Z01	Escutcheon, Top (16CH)
	1380525Z03	Escutcheon, Top (Dotted)
5	3380644Z01	Escutcheon, Label
6	3280533Z01	Seal, Control Top
7	6180527Z01	Litepipe, Tx
8	HHLN4213	Nameplate, MTX4500
9	1586059A01	Dust Cover, Univ Conn
10	1386058A01	Escutcheon, Univ Flex
11	1580666Z05	Front Cover
12	Non Field Replaceable	* Escutcheon, FM
13	7580532Z01	Keypad, Side Control
14	1380528Z01	Bezel, Side Control

Item	Motorola Part Number	Description
15	7586065A01	Keypad, Basic
	7586065A02	Keypad, Full,
	758568OZ07	Keypad, Full, Privacy Plus
16	0104010J09	Keypad Board Assembly
17	7580540Z01	Pad Display
18	5104949J05	LCD Module
19	7580637Z01	Pad, LCD Back
20	4280498Z01	Retainer, Keypad PCB
21	3586057A01	Felt, Speaker
22	1480577C01	Boot, Microphone
23	5085962A02	Speaker
24	5013920A04	Microphone
25	8480549Z01	Flex Speaker-Microphone
26	2113740A41	Cap, 33pF
27	4280504Z01	Retainer, Speaker
28	1480503Z01	Boot, Backup Battery
29	6062884G01	Backup Battery

Item	Motorola Part Number	Description
30	0304726J04	Screw
31	3980667Z01	Contact, Finger
32	See section 8.1	Ctrl/RF Board Assembly
33	8485615Z02	Flex, Keypad/Controller
34	1480652Z01	Insulator, Antenna
35	7580556Z01	Pad, Thermal
36	3280534Z01	Seal, Contact
37	3280536Z02	Gasket, O-Ring
38	3980698Z01	Contact, Ground (For UHF)
39	2780518Z01	Chassis
40	See Accessories Chapter	Battery
41	HLN9714	Beltclip

3.4 MTX150 Radio Exploded Mechanical View and Parts List

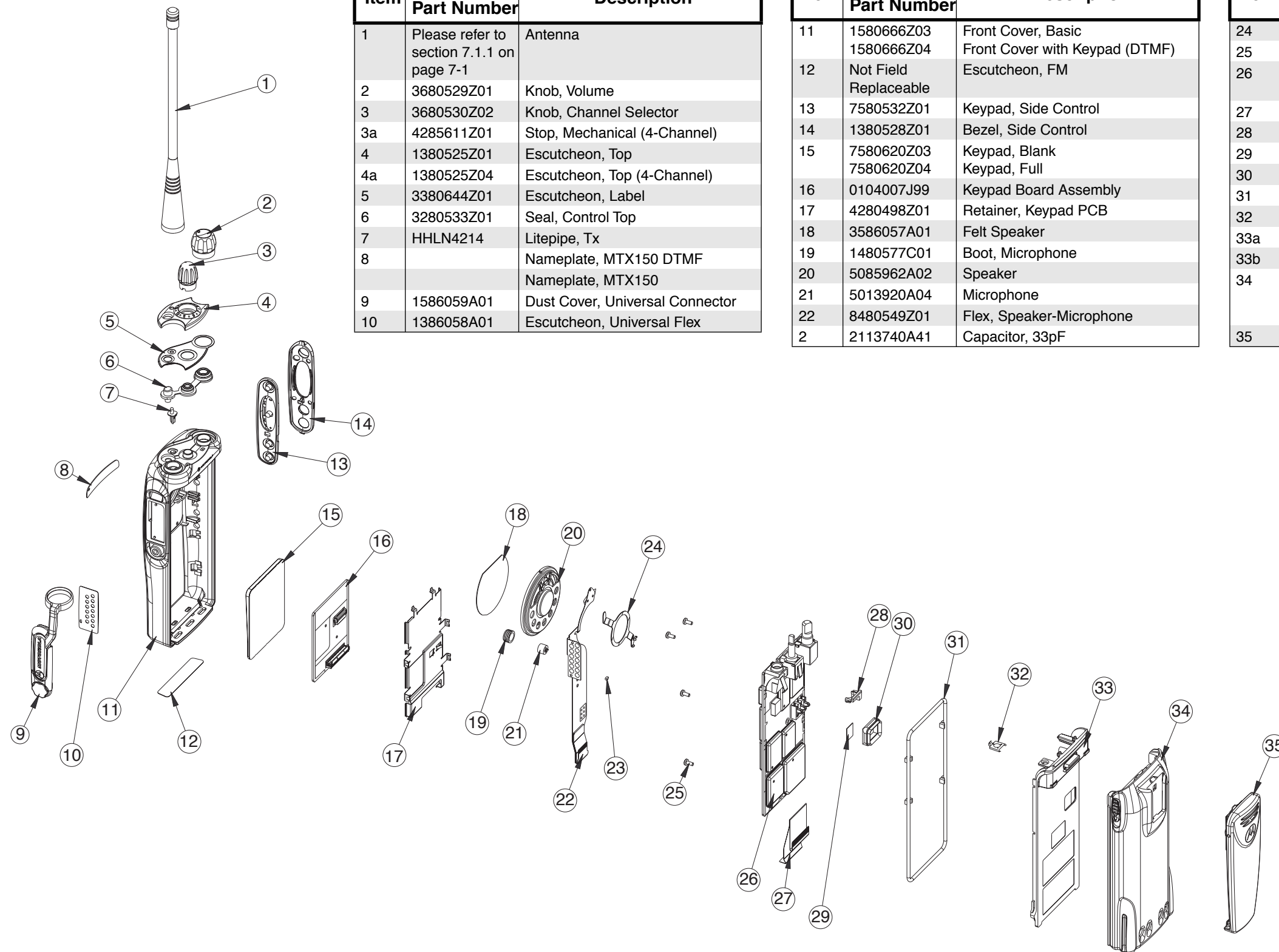

Item	Motorola Part Number	Description
1	Please refer to section 7.1.1 on page 7-1	Antenna
2	3680529Z01	Knob, Volume
3	3680530Z02	Knob, Channel Selector
3a	4285611Z01	Stop, Mechanical (4-Channel)
4	1380525Z01	Escutcheon, Top
4a	1380525Z04	Escutcheon, Top (4-Channel)
5	3380644Z01	Escutcheon, Label
6	3280533Z01	Seal, Control Top
7	HHLN4214	Litepipe, Tx
8		Nameplate, MTX150 DTMF Nameplate, MTX150
9	1586059A01	Dust Cover, Universal Connector
10	1386058A01	Escutcheon, Universal Flex

Item	Motorola Part Number	Description
11	1580666Z03 1580666Z04	Front Cover, Basic Front Cover with Keypad (DTMF)
12	Not Field Replaceable	Escutcheon, FM
13	7580532Z01	Keypad, Side Control
14	1380528Z01	Bezel, Side Control
15	7580620Z03 7580620Z04	Keypad, Blank Keypad, Full
16	0104007J99	Keypad Board Assembly
17	4280498Z01	Retainer, Keypad PCB
18	3586057A01	Felt Speaker
19	1480577C01	Boot, Microphone
20	5085962A02	Speaker
21	5013920A04	Microphone
22	8480549Z01	Flex, Speaker-Microphone
2	2113740A41	Capacitor, 33pF

Item	Motorola Part Number	Description
24	4280504Z01	Retainer, Speaker
25	0304726J04	Screw
26	See detailed service manual	Ctrl/RF Board Assembly
27	8480475Z02	Flex, Keypad/Controller
28	1480652Z01	Insulator, Antenna
29	7580556Z01	Pad, Thermal
30	3280534Z01	Seal, Contact
31	3280536Z01	Gasket, O-Ring
32	3980698Z01	Contact, Ground, Compliant, VHF
33a	2780518Z01	Chassis
33b	2780518Z03	Chassis
34	See section 7.1.5 on page 7-2	Battery
35	HLN9714	Beltclip

3.5 MTX1500 Radio Exploded Mechanical View and Parts List

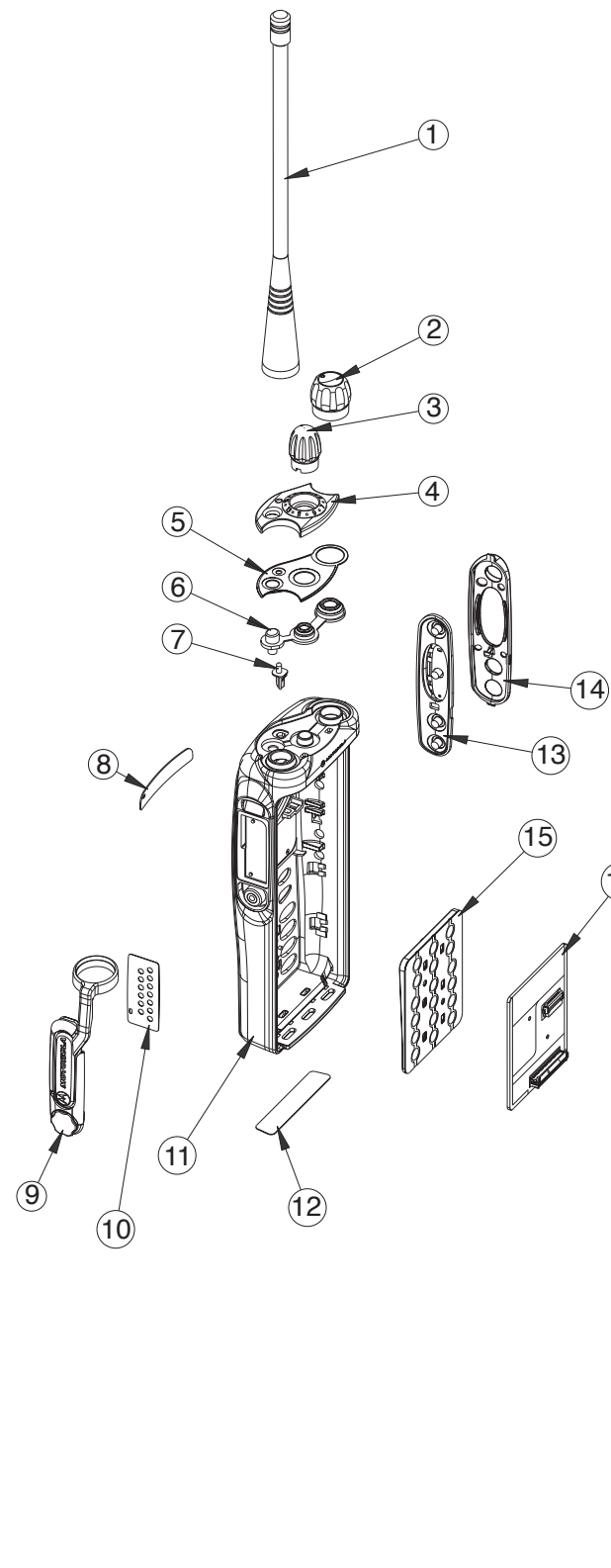

Item	Motorola Part Number	Description
1	Please refer to section 7.1.1 on page 7-1	Antenna
2	3680529Z01	Knob, Volume
3	3680530Z01	Knob, Channel Selector
4	1380525Z01	Escutcheon, Top
5	3380644Z01	Escutcheon, Label
6	3280533Z01	Seal, Control Top
7	6180527Z01	Litepipe, Tx
8	HHLN4215	Nameplate, MTX1500
9	1586059A01	Dust Cover, Universal Connector
10	1386058A01	Escutcheon, Universal Flex
11	1580666Z01 1580666Z02	Front Cover with DTMF Front Cover without DTMF
12		Escutcheon, FM
13	7580532Z01	Keypad, Side Control

Item	Motorola Part Number	Description
14	1380528Z01	Bezel, Side Control
15	7580620Z02	Keypad, Full
16	0104007J99	Keypad Board Assembly
17	7580540Z01	Pad Display
18	5104949J05	LCD Module
19	7580637Z01	Pad, LCD Back
20	4280498Z01	Retainer, Keypad PCB
21	3586057A01	Felt Speaker
22	1480577C01	Boot, Microphone
23	5085962A02	Speaker
24	5013920A04	Microphone
25	8480549Z01	Flex, Speaker-Microphone
26	2113740A41	Capacitor, 33pF
27	4280504Z01	Retainer, Speaker
28	1480503Z01	Boot, Backup Battery
29	6062884G01	Backup Battery

Item	Motorola Part Number	Description
30	0304726J04	Screw
31	3980667Z01	Contact, Finger
32	See detailed manual	Ctrl/RF Board Assembly
33	8480475Z02	Flex, Keypad/Controller
34	1480652Z01	Insulator, Antenna
35	7580556Z01	Pad, Thermal
36	3280534Z01	Seal, Contact
37	3280536Z01	Gasket, O-Ring
38	3980698Z01	Contact, Ground, Compliant
39	2780518Z01	Chassis
40	See section 7.1.5 on page 7-2	Battery
41	HLN9714	Beltclip

Chapter 4

Transceiver Performance Testing

For the missing sub-sections in this chapter, please refer to Basic Service Manual 68P80906Z54.

4.1 RF Test Mode

When the radio is operating in its normal environment, the radio's microcontroller controls the RF channel selection, transmitter key-up, and receiver muting. However, when the unit is on the bench for testing, alignment, or repair, it is removed from its normal environment and cannot receive commands from its system. Therefore, the internal microcontroller does not key the transmitter or unmute the receiver. This prevents the use of a normal tuning procedure. To solve this problem, a special "test mode" is incorporated into the radio.

Note 1: On UHF, LTR models, the radio must be in either conventional or LTR mode.

Note 2: The test mode procedure that follows assumes that the Customer Programming Software Front Panel Access screen has both the FPA and RF TEST boxes selected. Select from the programming screen to enable or disable certain features of the radio RF test mode.

- FPA entry not selected blocks all test modes.
- FPA entry selected and RF TEST not selected blocks RF test mode.
- FPA entry selected and RF TEST selected enables all test modes.

To enter the test mode for a display radio:

1. Turn the radio on.
2. Within ten seconds after the self test is complete, press 'side button 2', shown in Figure 4-1, five times in succession.
3. After "CSQ CHXX SP25" appears on the display, the radio is on channel XX (see **Note** on following page), carrier squelch mode, 25 kHz channel spacing. Each additional press of 'side button 2' (see Table 4-2) scrolls to the next channel spacing, and a corresponding set of tones are sounded. Refer to Figure 4-2 for test mode information for a two-line display radio.
4. Press 'side button 1' to scroll through the test environments listed in Table 4-1 in Basic Service Manual 68P80906Z54.
5. Press 'side button 2' for 3 seconds to switch the radio to the control head test mode. 'LCD Test' appears on the display.
6. Press 'side button 1' to turn on all the dots of the first character. Another 'side button 1' press turns on all the dots of the next character, continuing until the last character is reached.
7. Press 'side button 1' at the end of the LCD test to activate the 'Icon Test'. The next 'side button 1' press turns on the first icon.
8. Press 'side button 1' at the end of the Icon Test to activate the button test. Pressing any side button (except 'side button 1'), or any keypad button during the LCD test or Icon test immediately activates this test. A good button press is verified by a chirp.
9. Press 'side button 2' for 3 seconds in the control head test mode to return the radio to the RF Test mode.

10. Turn radio off to exit test mode.

Note: XX = channel number (01 - 14)

To enter the test mode for a non-display radio:

1. Turn the radio on.
2. Within ten seconds after the self test is complete, press 'side button 2' (Figure 4-1) five times in succession.
3. Press 'side button 1' the number of times listed in Table 4-1 to get the number of corresponding beeps.
4. Turn radio off to exit test mode.
5. To access all 14 test modes on a 4-channel radio, the frequency knob and mechanical stop sleeve must be removed (see paragraph 3-8 exploded view diagram).

Button Test (For models with "G" in location 10 of model number Example: AAH25RCH6**G**B6AN)

1. Press the orange button; "3/1" appears which indicates that switch 3 is in the closed condition.
2. Release the orange button; "3/0" appears which indicates that switch 3 is in the open condition.
3. Rotate the mode selector knob; "4/0" through "4/15" appears which indicates that knob 4 is in mode position 1 through 15.
4. Rotate the volume control; "2/0" through "2/255" appears.
5. Press SB1, view "96/1"; release, view "96/0".
6. Press SB2, view "97/1"; release, view "97/0".
7. Press SB3, view "98/1"; release view "98/0".
8. Press PTT button, view "1/1"; release view "1/0".

Keypad (For models with "G" in location 10 of model number Example: AAH25RCH6**G**B6AN)

1. Press 0, view "48/1"; release, view "48/0".
2. Press 1, view "49/1"; release, view "49/0".
3. Press 2, view "50/1"; release, view "50/0".
4. Press 3, view "51/1"; release, view "51/0".
5. Press 4, view "52/1"; release, view "52/0".
6. Press 5, view "53/1"; release, view "53/0".
7. Press 6, view "54/1"; release, view "54/0".
8. Press 7, view "55/1"; release, view "55/0".
9. Press 8, view "56/1"; release, view "56/0".
10. Press 9, view "57/1"; release, view "57/0".
11. Press *, view "58/1"; release, view "58/0".
12. Press #, view "59/1"; release, view "59/0".
13. Press <, view "128/1"; release, view "128/0".
14. Press HOME, view "129/1"; release, view "129/0".
15. Press >, view "130/1"; release, view "130/0".
16. Press Option Select1, view "135/1"; release, view "135/0".

17. Press Option Select2, view "136/1"; release, view "136/0".
18. Press Option Select3, view "137/1"; release, view "137/0".
19. Pressing SB2 for 3 seconds in the Control Head Test mode will cause the radio to return to the RF Test mode.

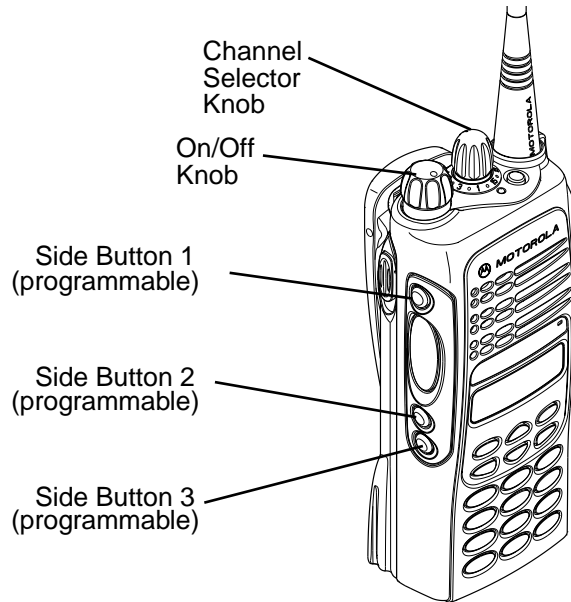

Figure 4-1. Radio Side Button Locations

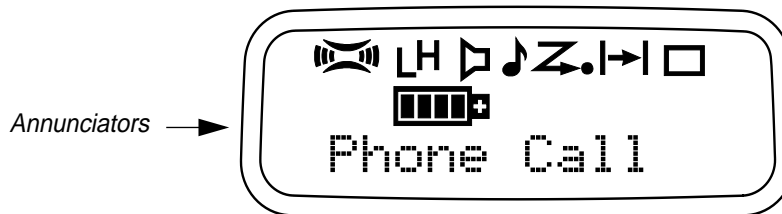

Figure 4-2. Two-Line Display

Table 4-1. Receiver Performance Checks

Test Name	Service Monitor	Radio	Test Set	Comments
Reference Frequency	Mode: PWR MON 4th channel test frequency* Monitor: Frequency error Input at RF In/Out	TEST MODE, Test Channel 4 carrier squelch out- put at antenna	PTT to continu- ous (during the performance check)	Frequency error to be ± 600 Hz UHF
Rated Audio	Mode: GEN Output level: 1.0mV RF 4th channel test frequency* Mod: 1kHz tone at 3kHz deviation Monitor: DVM: AC Volts	TEST MODE Test Channel 4 carrier squelch	PTT to OFF (center), meter selector to Audio PA	Set volume control to 3.16Vrms
Distortion	As above, except to distort- ion	As above	As above	Distortion 3.0% Typical
Sensitivity (SINAD)	As above, except SINAD, lower the RF level for 12dB SINAD.	As above	PTT to OFF (center)	RF input to be 0.25 μ V
Noise Squelch Threshold (only radios with conven- tional sys- tem need to be tested)	RF level set to 1mV RF	As above	PTT to OFF (center), meter selection to Audio PA, speaker/load to speaker	Set volume control to 3.16Vrms
	As above, except change fre- quency to a conventional system. Raise RF level from zero until radio unsquelches.	out of TEST MODE; select a conven- tional system	As above	Unsquelch to occur at <0.25 μ V. Preferred SINAD = 8dB

* See Table 4-4 of Basic Service Manual 68P80906Z54 for Test Frequencies.

Table 4-2. Transmitter Performance Checks

Test Name	Service Monitor	Radio	Test Set	Comments
Reference Frequency	Mode: PWR MON 4th channel test frequency* Monitor: Frequency error Input at RF In/Out	TEST MODE, Test Channel 4 carrier squelch	PTT to continuous (during the performance check)	Frequency error ± 600 Hz UHF
Power RF	As above	As above	As above	Refer to Specifications
Voice Modulation	Mode: PWR MON 4th channel test frequency* atten to -70dB, input to RF In/Out Monitor: DVM, AC Volts Set 1kHz Mod Out level for 0.025Vrms at test set, 80mVrms at AC/DC test set jack	As above	As above, meter selector to mic	Deviation: UHF: ≥ 4.0 kHz but ≤ 5.0 kHz (25 kHz Ch Sp) Global. 4KHz (20 kHz Ch Sp) U.S. and Canada.
Voice Modulation (internal)	Mode: PWR MON 4th channel test frequency* atten to -70dB, input to RF In/Out	TEST MODE, Test Channel 4 carrier squelch output at antenna	Remove modulation input	Press PTT switch on radio. Say "four" loudly into the radio mic. Measure deviation: UHF: ≥ 4.0 kHz but ≤ 5.0 kHz (25 kHz Ch Sp)
High-Speed Data Modulation***	As above	TEST MODE, Test Channel 4 high speed output at antenna	PTT to continuous (during the performance check)	Deviation: UHF: ≥ 2.5 kHz but ≤ 3.5 kHz (25 kHz Ch Sp)
Low-Speed Data Modulation UHF	As above	TEST MODE, Test Channel 4 TLS output at antenna	PTT to continuous (during the performance check)	Deviation: UHF: ≥ 500 Hz but ≤ 1000 Hz (25 kHz Ch Sp)
DTMF Modulation	As above, 4th channel test frequency*	TEST MODE, Test Channel 4 DTMF output at antenna	As above	Deviation: UHF: ≥ 3.05 kHz but ≤ 3.45 kHz (25 kHz Ch Sp)
PL/DPL Modulation	As above 4th channel test frequency* BW to narrow	TEST MODE, Test Channel 4 TPL DPL	As above	Deviation: UHF: ≥ 500 Hz but ≤ 1000 Hz (25 kHz Ch Sp)

***MDC

* See Table 4-4 of Basic Service Manual 68P80906Z54 for Test Frequencies.

This page intentionally left blank.

Chapter 5

Radio Tuning, Programming, and Cloning

5.1 Cloning (Conventional and LTR)

Cloning is the same for both the Conventional and LTR radio. Cloning is the process of copying the content of one radio (source radio) into another radio (target radio). Radio content refers to system-type features such as frequency, squelch type options, trunking, etc.

Note: Cloning can be performed only on radios with identical model numbers and software options.

Radio functionality inherent in one radio cannot be cloned to another radio that does not contain the same functionality. Tuning and alignment information are not transferable and are not affected by cloning.

Signaling Identification Numbers (IDs) are duplicated in the cloning process. Unique IDs may be assigned with the CPS.

Note: Unsuccessful cloning attempts will not damage the radio.

Procedure:

1. Turn source and target radios off.
2. Connect cloning cable to side connector of both radios.
3. Turn on target radio.
4. On source radio, simultaneously press 'side buttons 1 and 2', shown in Figure 5-3, then turn radio on. Both radios produce a "clone-entry" tone and turn on their green LEDs. Display radios show "**Cloning To**" (source radio) and "**Program**" (target radio).
5. Release both side buttons. The electronic transfer process begins and will take approximately one to three minutes.
6. When cloning is completed, both radios reset themselves and turn their green LEDs off. The source radio produces a "clone-exit" tone and displays "**Clone Complete**".
7. Turn both radios off.
8. Disconnect the cloning cable from both radios and turn them on for normal operation.

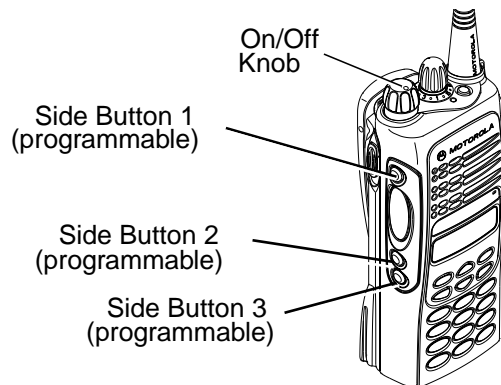

Figure 5-1. Radio Side Button Locations

5.1.1 Error Codes (Display Radios Only)

- **“ERR: Mismatch”** - The model numbers or the code plug versions are not the same for both radios. Cloning cannot be performed.
- **“ERR: Timeout”** - Communication between the two radios was not established or was disrupted during the cloning process. If this occurs, check the cloning cable and all connections. Repeat the cloning procedure.

5.2 Cloning (Privacy Plus)

This function is used to copy codeplug information from one radio to another one. A radio and RIB must be properly connected to the computer and power turned on before you attempt the PROGRAM function. The time required to PROGRAM a codeplug will depend on the computer and the size of the codeplug you are programming. Only radios with the same model number, protocol option and codeplug version may be cloned. Trunked radios may not be cloned unless System Keys have been loaded for each trunking system ID. Tuning and alignment information are not transferable and are not affected by cloning. Signalling Identification are duplicated in the cloning process. Unique IDs may be assigned with the CPS.



WARNING: Do NOT turn off the radio or disconnect it from the computer while attempting to PROGRAM the codeplug. Interrupting the programming process WILL DESTROY the codeplug contents and completely DISABLE the radio.

Procedure:

1. Use the READ RADIO function to read the radio codeplug to be cloned. i.e. the “Source” codeplug.
2. If required, enter the Individual ID’s for the new radio. Trunking system keys (or FTR Key) are required for cloning the Trunking System Data.
3. If required, go to the SDF merge screen, to merge SDF Trunking System Data.
4. Connect “Target” radio to the computer and press READ SERIAL NUMBER button to read the “Target” radio’s serial number. This number must be different from the “Source” codeplug, or the cloning progress will fail.
5. Connect “Target” radio to the computer, and press the PROGRAM button to program the “Source” codeplug into the “Target” radio.
6. The CPS will validate the code plug.
7. If it fails a warning screen will be displayed informing of the incompatibility between the CPS and code plug, otherwise the information is written into the radio’s code plug.

Chapter 6

Power Up Self-Test

6.1 Error Codes - Conventional and LTR Radios

Turning on the radio starts a self-test routine that checks the RAM, ROM checksum, EEPROM hardware, and EEPROM checksum. If these checks are successful, the radio generates two high-pitched self-test pass tones, or a musical tone (selected in CPS). If the self-test is not successful, one low-pitched tone is heard. Radios with displays are able to display the error codes. The displayed error codes and related corrections are listed as follows:

Table 6-1: Power-up Display Codes - (Conventional Radios)

If the error code displayed is...	then, there is a...	To correct the problem...
"RAM TST ERROR"	RAM test failure.	Retest the radio by turning it off and turning it on again. If message reoccurs, replace RAM (U405).
"ROM CS ERROR"	Wrong ROM checksum.	Reprogram FLASH memory, then retest. If message reoccurs, replace ROM (U406).
"EEPROM HW ERROR"	Codeplug structure mismatch or non existence of codeplug.	Reprogram codeplug with correct version and retest radio. If message reoccurs, replace EEPROM (U407).
"EEPROM CS ERROR"	Wrong codeplug checksum.	Reprogram codeplug.
No Display	Bad display module connection or damaged display module.	Check connection between main board and display module or replace with new display module.

6.2 Error Codes - Privacy Plus

At power-up, the radio performs cursory tests to determine if its basic electronics and software are in working order. Problems detected during these tests are presented as error codes on the radio display. The presence of an error code should prompt the user that a problem exists and that a service technician should be contacted. Self-test errors are classified as either fatal or non-fatal. Fatal errors will inhibit user operation, non-fatal errors will not. Use Table 6-2: Power-up Display Codes to aid in understanding particular power-up error code displays.

Table 6-2: Power-up Display Codes

Failure Display	Type of Failure	Description	Possible Source
FAIL 01/81	FATAL	External ROM/Flash checksum error	Bad ROM data, Defective ROM
FAIL 01/82	FATAL	External EEPROM checksum error	Bad external codeplug data, Defective external EEPROM
ERROR 01/02	NON-FATAL	External EEPROM checksum error	Bad external codeplug data
FAIL 01/84	FATAL	External EEPROM checksum blank	Unprogrammed external codeplug data
FAIL 01/88	FATAL	External RAM error	Defective RAM
FAIL 01/90	FATAL	Hardware failure	Defective IC
FAIL 01/92	FATAL	Internal EEPROM checksum error	Bad internal codeplug data, Defective microcontroller
ERROR 01/12	NON-FATAL	Internal EEPROM checksum error	Bad internal codeplug data
FAIL 01/94	FATAL	Internal EEPROM checksum blank	Unprogrammed internal codeplug data
FAIL 01/98	FATAL	Internal RAM error	Defective microcontroller

NOTE Due to the nature of fatal ROM & RAM error, it may not be possible to present an error code on the display. In these cases the radio will attempt to display the appropriate error code, generate an illegal mode tone for one second and then reset its microcontroller.

Chapter 7

Accessories

7.1 HT750•LS/MTX450/MTX4500/MTX150/MTX1500 Accessories

7.1.1 Antennas

UHF 1	403-470 MHz, Ferrule Connector
PMAE4002	403-433 MHz Stubby
PMAE4003	433-470 MHz Stubby
NAE6483	403-520 MHz Whip
VHF	136-174 MHz, Ferrule Connector
PMAD4012	Stubby Antenna, 136-155 MHz
PMAD4013	Stubby Antenna, 155-174 MHz
PMAD4014	14 cm. Helical, Standard Length - 136-155 MHz (Red Code)
PMAD4015	14 cm. Helical, Standard Length - 155-174 MHz (Black Code)
PMAD4023	14 cm. Helical, Standard Length -150-161 MHz
PMAD4025	Stubby Antenna, 150-161 MHz

7.1.2 Carrying Accessories

All Models/All Battery Chemistries:

HLN9952	Carry Holder, Belt Clip
HLN9714	Spring 2-1/2" Belt Clip
HLN9701	Nylon Carry Case with Beltloop

7.1.3 Carry Cases

HT750•LS, MTX450	Ultra-High and High Capacity Battery Carry Cases
HLN9665	Standard Leather Case, Beltloop
HLN9676	Standard Leather Case, Swivel
MTX4500	Ultra-High and High Capacity Battery Carry Cases
HLN9689	Standard Leather Case, DTMF, Beltloop
HLN9694	Standard Leather Case, DTMF, Swivel
HT750•LS,MTX450	Lithium Ion Battery Carry Cases
HLN9652	Standard Leather Case, Beltloop, Thin Battery

HLN9670	Standard Leather Case, Swive, Thin Battery
MTX4500	Lithium Ion Battery Carry Cases
HLN9677	Standard Leather Case, DTMF, Beltloop, Thin Battery
HLN9690	Standard Leather Case, DTMF, Swivel, Thin Battery

7.1.4 Chargers

AAHTN3000	120V Rapid Rate Single Unit Charger, U.S. 3-Prong Plug
HTN9000	Rapid Rate Single Unit (Pocket Only)
EPNN5751	120V Transformer Only
AAHTN3003	120V Multi-Unit Rapid Rate Charger, U.S. 3-Prong Plug
NLN7967	Mount, Wall Kit for Multi-Unit Charger

7.1.5 Batteries

HNN9008	1200 mAH NiMH High Capacity Battery (Standard With Unit)
HNN9009	1900 mAH NiMH Ultra High Capacity Battery
HNN9010	1850 mAH NiMH Ultra High Capacity Battery Factory Mutual (FM)
HNN9011	1200 mAH NiCd High Capacity Battery Factory Mutual (FM)
HNN9012	1350 mAH NiCd High Capacity Battery
HNN9013	1200 mAH Lithium Ion High Capacity Battery

7.1.6 Adapters

AAHLN9716	GP300/P1225/P1225•LS Audio Accessory Adapter-FM Approved (not compatible with BDN6706 or BDN6646)
-----------	---

7.1.7 Miscellaneous

HLN9820	Dust Cover for Accessory Connector
HLN9793	Charger Insert Spacer - Compatible with "A" version chargers only
HLN9794	Charger Insert Spacer - Compatible with "B" version chargers only

7.1.8 Service Aids

H5177	Customer Programming Software (CPS) - 3 Years Subscription Includes AARKN4074 Programming Test Cable
RKN4073	Cloning Cable, portable Professional Radio Only
AARKN4074	Programming/Test Cable [(requires a Radio Interface Box (RIB))]
RKN4075	Ribless Programming Cable (provides interface between computer and portable radio)
A0180305G54	Battery Eliminator Cable. Requires RLN4510 (7.5 volt source)

RLN4510	7.5 Volt Universal Battery Eliminator
AA8180384F68	Bench test housing eliminator/test fixture. Requires RLN4510 7.5V
HHLN4134	Ferrule to BNC adapter
RLN4460	Test Box
HVN9025	Customer Programming Software -CD ROM (HT750•LS)
HVN9067	Customer Programming Software -CD ROM (MTX450 and MTX4500)

7.1.9 Audio Accessories

AARMN4017	Ultra-Lightweight Headset with Boom Microphone -FM Approved
AARMN4018	Lightweight Headset with Boom Microphone and In Line PTT - FM Approved
AARMN4019	Medium Weight Dual Muff Headset, Over the Head with Noise Cancelling Mic and IN Line PTT - FM Approved
AARMN4020	Heavy Duty Behind the Head Headset with Noise Cancelling Boom Microphone and PTT on Earcup - FM Approved Note: NOT for use with MTX450 and MTX4500
AARMN4021	Ear Piece without Volume Control (Beige) - FM Approved
AARMN4022	2 Wire Ear Piece with Microphone and PTT (Beige) - FM Approved
AARMN4028	Ear Piece without Volume Control (Black) - FM Approved
AARMN4029	2 Wire Ear Piece with Microphone and PTT (Black) - FM Approved

7.1.10 Option Boards (HT750•LS only)

AAHLN9729	DTMF Decode Option Board with Manual (Field Install only)
AAHLN9725	Voice Storage Option Board with Manual (Field Install only)

7.1.11 Remote Speaker Microphones

AAHMN9052	Remote Speaker Standard Microphone - FM Approved
AAHMN9053	Remote Speaker Noise Cancelling Microphone with 3.5 mm. Audio Accessory Jack - FM Approved
AAHKN9055	Replacement Cable for Standard and Noise Cancelling Microphone

7.1.12 Manuals

6881088C41	HT750•LS User Guide (French, and English)
6881093C96	MTX150/MTX450 User Guide (French, and English)
6881093C97	MTX1500/MTX4500 User Guide (French, and English)
6881093C57	HT750•LS/MTX150/MTX1500/MTX450/MTX4500 Service Manual Supplement, Level 1 & 2 (English)
6880906Z54	Basic Service Manual Level 1 & 2 (English)

7.1.13 Retrofit Front Cover Kits

HLN4065A	DTMF Retrofit Kit (HT750•LS Only)
----------	-----------------------------------

Chapter 8

Model Chart and Test Specifications

8.1 UHF 403-470 MHz (HT Series)

HT Series, UHF, 403-470 MHz		
Model		Description
AAH25RDC9DU3AN		HT750•LS, 403-470 MHz, 4W, 16-Ch
	Item	Description
X	PMLE4148	HT750•LS Back Cover Kit
X	PMLN4216	HT750•LS Front Housing Kit
X	NAE6483	(Whip) antenna (403-512 MHz)
X	6881088C41	HT750•LS User Guide (French/English)
x = Indicates one of each is required.		

8.2 UHF 403-470 MHz (MTX Series)

MTX Series, 403-470 MHz		
Model		Description
AAH25RDC9GB3AN		MTX450, 403-470 MHz, 4W, 16-Ch
	AAH25RDH9GB6AN	MTX4500 403-470 MHz, 4W, 160-Ch
	Item	Description
X	PMLE4192	MTX450 Back Cover Kit
	X PMLE4193	MTX4500 Back Cover Kit
X	PMLN4216	Front Housing Kit (Non-Keypad)
	X PMLN4373	Front Housing Kit (Keypad)
X	X PMAE4002	Antenna, Stubby, 403-433 MHz
X	X PMAE4003	Antenna, Stubby, 433-470 MHz
X	X NAE6483	Antenna, Whip, 403-520 MHz
X	6881093C96	MTX450 User Guide (French/English)
	X 6881093C97	MTX4500 User Guide (French/English)
x = Indicates one of each is required.		

8.3 VHF 136-174 MHz (MTX Series)

MTX Series, 136-174 MHz		
Model		Description
AAH25KDC9GE3AN		MTX150, 136-174 MHz, 5W, 16-Ch
AAH25KDH9GE6AN		MTX1500 136-174 MHz, 5W, 160-Ch
	Item	Description
X	PMLD4170	MTX150 Back Cover Kit
	X PMLD4171	MTX1500 Back Cover Kit
X	PMLN4216	Front Housing Kit (Non-Keypad)
	X PMLN4373	Front Housing Kit (Keypad)
X	X PMAD4012	VHF Stubby Antenna, 136-155 MHz
X	X PMAD4013	VHF Stubby Antenna, 155-174 MHz
X	X PMAD4014	14 cm. Helical, Standard Length - 136-155 MHz (Red Code)
X	X PMAD4015	14 cm. Helical, Standard Length - 155-174 MHz (Black Code)
X	X PMAD4023	14 cm. Helical, Standard Length -150-161 MHz
X	X PMAD4025	VHF Stubby Antenna, 150-161 MHz
X	6881093C96	MTX150 User Guide (French/English)
	X 6881093C97	MTX1500 User Guide (French/English)
x = Indicates one of each is required.		

8.4 Specifications - HT750•LS/MTX450/MTX4500/MTX150/MTX1500 Radios

General		
Specification	UHF	VHF
Model Numbers: HT750•LS/MTX450 MTX4500 MTX150 MTX1500	AAH25RDC9GB3AN AAH25RDH9GB6AN	AAH25KDC9GE3AN AAH25KDH9GE6AN
Frequency Range:	403-470 MHz	136-174 MHz
Frequency Stability: (-30°C to +60°C, 25°C Ref.)	±5 PPM @ 25 KHz ±2.5 PPM @ 12.5 KHz	
Channel Capacity: HT750•LS/MTX450 MTX4500	16 Channels 160 Channels	
Channel Spacing:	12.5/20/25 KHz	
Power Supply:	7.5 volts rechargeable battery	
Dimensions: With NiMH High Capacity Battery: With NiMH Ultra-High Capacity Battery: With NiCd Battery: With Lilon Battery:	5.40 in. x 2.26 in. x 1.50 in. (137mm x 57.5 mm x 37.5mm) 5.40 in. x 2.26 in. x 1.60 in. (137mm x 57.5 mm x 40mm) 5.40 in. x 2.26 in. x 1.60 in. (137mm x 57.5 mm x 40mm) 5.40 in. x 2.26 in. x 1.30 in. (137mm x 57.5 mm x 33mm)	
Weight: With NiMH High Capacity Battery: With NiMH Ultra-High Capacity Battery: With NiCd Battery: With Lilon Battery:	15.0 ounces (420 grams) 17.5 ounces (500 grams) 15.8 ounces (450 grams) 12.5 ounce (350 grams)	
Average Battery Life @ 5-5-90 Duty Cycle*: With NiMH High Capacity Battery: With NiMH Ultra-High Capacity Battery: With NiCd Battery: With Lilon Battery:	Low Power 11 hours 14 hours 12 hours 11 hours	High Power 8 hours 11 hours 9 hours 8 hours
Sealing:	Passes rain testing per IP54 and MIL-STD 810E	
Shock:	Meets MIL-STD-810-C,D & E and TIA/EIA 603	
Vibration:	Meets MIL-STD-810-C,D & E and TIA/EIA 603	
Dust:	Meets MIL-STD-810-C,D & E and IP54	
Humidity:	Meets MIL-STD-810-C,D & E and TIA/EIA 603	

* 5% receive, 5% transmit, 90% standby

Transmitter		
Specification	UHF	VHF
Power Output NiMH @ 7.5V:	1W/4W	1W/5W
Spurs/Harmonics:	-36 dBm < 1GHz -30 dBm > 1 GHz	
Audio Response: (from 6 dB/oct. Pre-Emphasis, 300 to 3000 Hz)	+1 to -3 dB	
Audio Distortion: @ 1000 Hz, 60% Rated Max. Dev.	< 5%	
Modulation Limiting:	±2.5 KHz @ 12.5 KHz ±4.0 KHz @ 20 KHz ±5.0 KHz @ 25 KHz	
FM Hum and Noise:	-40 dB Typical	

Receiver		
Specification	UHF	VHF
Sensitivity (12 dB SINAD) EIA:	0.35 μ V	
Sensitivity (20 dB SINAD) ETS:	0.5 μ V	
Intermodulation:	-65 dB	
Adjacent Channel Selectivity ETS:	-60 dB @ 12.5 KHz -70 dB @ 20/25 KHz	
Spurious Rejection:	-70 dB	
Rated Audio:	0.5 W	
Audio Distortion @ Rated Audio:	3% Typical	
Hum and Noise: (With Low Level Expansion Enabled)	-45 dB @ 12.5 KHz/-50 dB @ 20/25 KHz	
Audio Response: (from 6 dB/oct. de-Emphasis, 300 to 3000 Hz)	+1 to -3 dB	
Conducted Spurious Emission:	-57 dBm < 1 GHz -47 dBm > 1 GHz	

Specifications subject to change without notice. All electrical specifications and methods refer to EIA/TIA 603 standards. PRO Series radios meet or exceed requirements of MIL STD 810 C, D, E.

NOVA COMMUNICATIONS



MOTOROLA

Authorized Dealer & Service Center



MOTOSTAR

180 Excellence Award



MOTOROLA

*Authorized Channel Partner
Fixed Wireless Broadband Solutions*

Nova Communications

Canada's Premier Supplier
of Wireless Communications
We Put Wireless to Work!
1-877-721-7070

www.novacomcommunications.com

quality

versatility



® Motorola, Professional Radio - As Dedicated As You Are, HT Series, MTX Series, and Call Alert are trademarks of Motorola, Inc. LTR is a registered trademark of E.F. Johnson Company.
© 2000, 2001 Motorola, Inc. All Rights Reserved. Printed In U.S.A.



68P81093C57-B